

A picket fence can add the finishing touch to your home. When you build it yourself, with the help of Home Timber and Hardware, you can create the exact look you want. Your fence will keep the kids and family pets safely inside and keep unwanted guests outside, giving you the privacy you want. Choose a design that complements your home and garden, make sure you've got the right tools and materials, and you're on your way.



TIMBER CHECKLIST

To do the job correctly it is important to select the right timbers for outdoor use. These are called "durable timbers" and will last for a long time when buried in the ground or exposed to the weather.

Typical timbers which are suitable for a picket fence are - treated pine, cyprus pine, jarrah, hardwood, and red gum. Your nearest Home Timber and Hardware can help you select the best local timbers for your job. It is also important to use the correct sizes for the different members. Some typical sizes for a 1.5 metre high fence are -

- | | |
|--|--|
| <input type="checkbox"/> Posts 125 x 75mm | <input type="checkbox"/> Plinth 150 x 25 mm |
| <input type="checkbox"/> Rails 100 x 38 mm | <input type="checkbox"/> Pickets 90 or 70 x 22mm |

OTHER MATERIALS REQUIRED

- | | |
|---|--|
| <input type="checkbox"/> Pre mix concrete | <input type="checkbox"/> Tarp or plastic sheet to protect timber whilst not in use |
| <input type="checkbox"/> Galvanised Nails | |

TOOL CHECKLIST

- | | |
|---|---|
| <input type="checkbox"/> Tape Measure | <input type="checkbox"/> Stringline |
| <input type="checkbox"/> Electric Drill | <input type="checkbox"/> Shovel or Post hole digger |
| <input type="checkbox"/> Claw Hammer | <input type="checkbox"/> Spirit Level |
| <input type="checkbox"/> Rubber Mallet | <input type="checkbox"/> Crowbar |

HINTS & TIPS



- Don't use plain steel nails, as they'll eventually rust and leave brown stains on the fence. Use galvanised fasteners for all outdoor fixings.
- When the timber is delivered, stack it level and off the ground. Cover with an old tarp or heavy plastic to protect from the weather.
- Measure post holes from centre to centre (not edge to edge) to ensure they are all consistent spacing.
- Measure twice, cut once.
- When using power tools, wear eye goggles, ear muffs and protective clothing.
- Pre-drill nail holes slightly undersize (especially pickets) to prevent the timber from splitting.
- Treat ends and all notches of all timbers with a water repellent formulation to prolong the service life of the fence.
- Leave painting or staining a few months for the timber to weather slightly and to allow any shrinkage to occur.

PLANNING

Planning the fence requires you to select the location, style and height of the fence, and to check with your local council if a building permit is required, or if there are certain regulations affecting your preferred style. In addition, it would be wise to have a registered

surveyor do a site survey to ensure your fence will be on the correct boundaries. Don't forget to plan for a gate, and perhaps incorporate a new letterbox.

STEP 1 PREPARATION

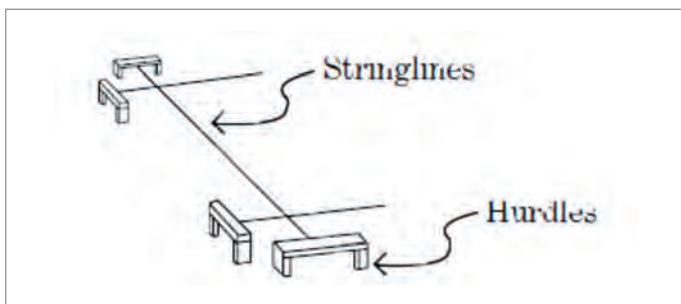

Determine both end post locations and hammer stakes in the ground to mark them. Run a string line between these to mark the fence line, then determine the gate post locations and also mark these. You can now mark out the locations of the intermediate posts at even spacing (typically 1.8 to 2.4 metres apart).

STEP 2 INSTALLING THE POSTS

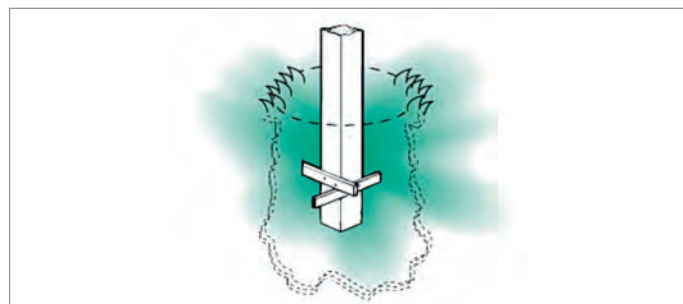
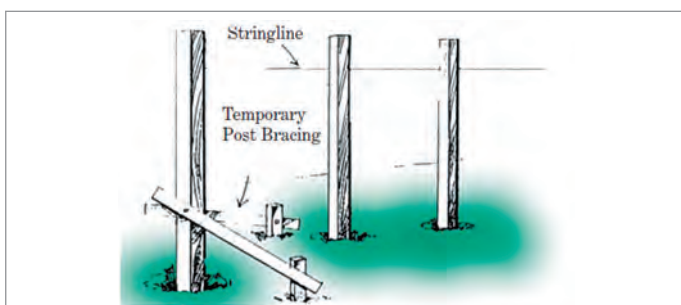

Dig the holes for the end posts first, 300mm square and 600mm deep. If a picket fence is higher than 1.8 metres, holes should be deeper than 600mm.

Place the posts central in the holes and attach two braces as shown. Plumb the posts with a spirit level and fasten the braces securely. If the soil is sandy then additional braces below the ground are required, as shown. Fill the holes completely with Premix

concrete, or make up a cement-soil mix (6 parts soil to 1 part cement) and consolidate by hard ramming with a crow bar. Check the posts with a spirit level and adjust to plumb if necessary. The top of the footings should be sloped away from the posts to drain away water. The remainder of the posts can be installed in the same way, using a string line to ensure that they all are in a straight line. Allow a few days for the cement to cure before proceeding.

This information is intended as a guide only. Please check with your council for any relevant laws before commencing any work. Always wear personal protection equipment and use tools safely.

STEP 3 FITTING THE RAILS AND PLINTH

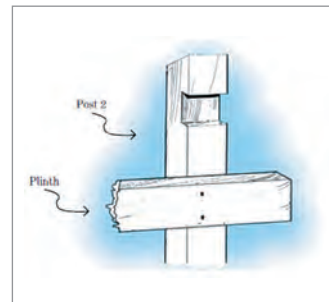
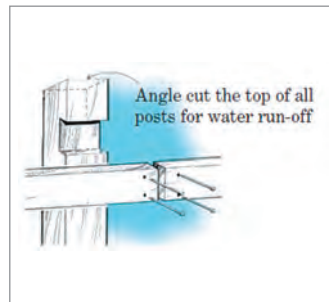
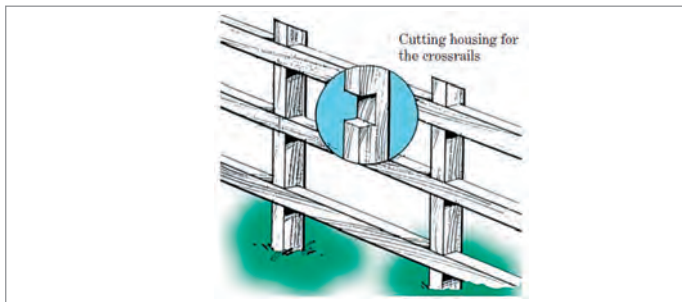

The posts now have to be notched to fit the rails. Attach the string line on the end posts at the required height of each rail, and mark out the appropriate position on each intermediate post.

Most picket fences have only two cross rails, with the top rail 150mm down from the top of the posts, and the bottom rail 150mm above the plinth. Use a saw and chisel to cut the notches in the posts the same depth as the thickness as the rails.

Fix the rails to the posts with two 75 x 3.75mm galvanised bullet head nails. Joins in the rails should be butted together in the centre of the post notch. Stagger the joins in the rails over different posts.

When the rails are in place, locate the plinth at the base of the posts. The plinth is fixed on the face of the posts - it is not notched in. Plinths should run parallel to the ground, and a little above it. Use small packers to sit the plinth on before fixing in place. Fasten the plinth with two 75 x 3.75mm galvanised bullet head nails.

STEP 4 FIXING THE PICKETS

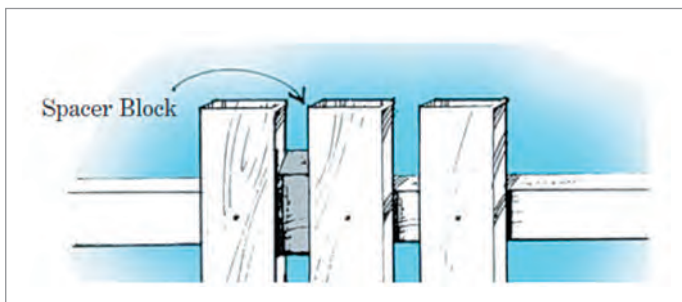

At this stage it is necessary to select the shape along the top of the fence - straight or curved. For a straight top use a stringline along the posts to line up the pickets. A curved top can be created by also using a stringline, allowing it to go slack in the middle to the desired shape. Measure the distance from the low point of the string to the plinth, and use this measurement to establish the same curve for the other bays. When fixing the pickets it is important to make them evenly spaced. The usual gap is between 25 to 35mm. Fix the two end pickets (checking for true vertical with a spirit level) and then work from one end using a "spacer" to keep the gaps uniform. Fix the pickets with two 50 x 2.8mm galvanised bullet head nails to each rail.

STEP 5 FINISHING

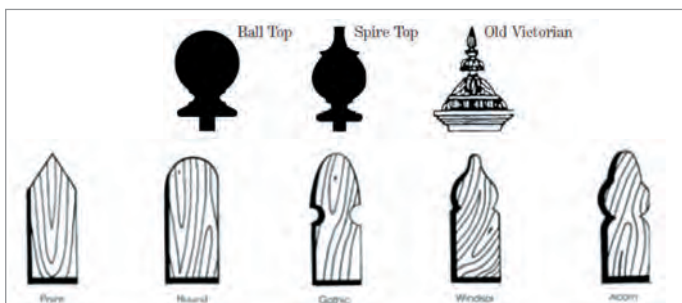

Finishing touches are important to make your fence as attractive as possible. For example, top the posts with "capitals" as illustrated below. When exposed to the weather, all timbers eventually lose their colour and turn grey.

Therefore, the application of a coat of paint (or stain) will enhance the appearance of the fence, as well as provide additional protection from the weather. Several types of paints and stains are suitable for external use, your Home Timber and Hardware experts can help you select the right colour and paint types for your project.

This information is intended as a guide only. Please check with your council for any relevant laws before commencing any work. Always wear personal protection equipment and use tools safely.